

# Chorruaylighting

ออกแบบ ผลิต จำหน่าย รับสั่งทำโคมไฟสั่งทำตามแบบ  
ผลิตโคมไฟภายนอก โคมไฟประติมากรรม โคมไฟตกแต่งสวน



#### โคมไฟ

- โคมทางเดิน Bollard
- โคมไฟพาด Bracket Light
- โคมฉายน้ำ Flood Light
- โคมไฟแต่งสวน Garden Light
- โคมฝังพื้น Inground
- โคมห้อยเพดาน Pendant Light
- โคมไฟเสา Pole Light

- โคมไฟพวย Post Top Light
- โคมสปอร์ตไลท์ Spot Light
- โคมพิงบันได Step Light
- โคมผนัง Wall Mount Light
- โคมใต้น้ำ Under Water Light
- โคมไฟถนน Street Light
- โคมไฟประติมากรรม Sculpture

#### โคมไฟประติมากรรม

- โคมไฟ กวนี่
- โคมไฟ ทอส์
- โคมไฟประติมากรรม 12 ราศี
- โคมไฟ รูปสัตว์ต่างๆ
- ป้ายระฆัง ป้ายถนน

#### หลอดอุโมงค์นิยมน อีแอลแอล

- หลอดไฟเบอร์กลาส เอเอ็ม
- หลอดอุโมงค์นิยมน อีแอลแอล

รับผลิตงานหล่ออัลลอย อลูมิเนียม ไฟเบอร์กลาส และ สร้างแบบแม่พิมพ์ โมลด์สินค้า ตามแบบลูกค้า  
รับทั้งงานเล็ก-งานใหญ่ งานสวยงาม ราคาโรงงาน โดยช่างผู้ชำนาญงานเป็นเวลามากกว่าสี่สิบปี



บริษัท ฆ รวยไลท์ติ้ง จำกัด

CHORRUAYLIGHTING CO., LTD.

59/188 ตำบลคอกระบือ อำเภอเมือง จังหวัดสมุทรสาคร 74000

59/188 Kokkrabue, Muang, Samutsakhon 74000

E-mail : ruayfoundry\_new@hotmail.com, crlighting@gmail.com www.chorruaylighting.com, www.โรงงานโคมไฟ.com

Tel./Fax. : +66 34 82 3552

**08-1929-1621**



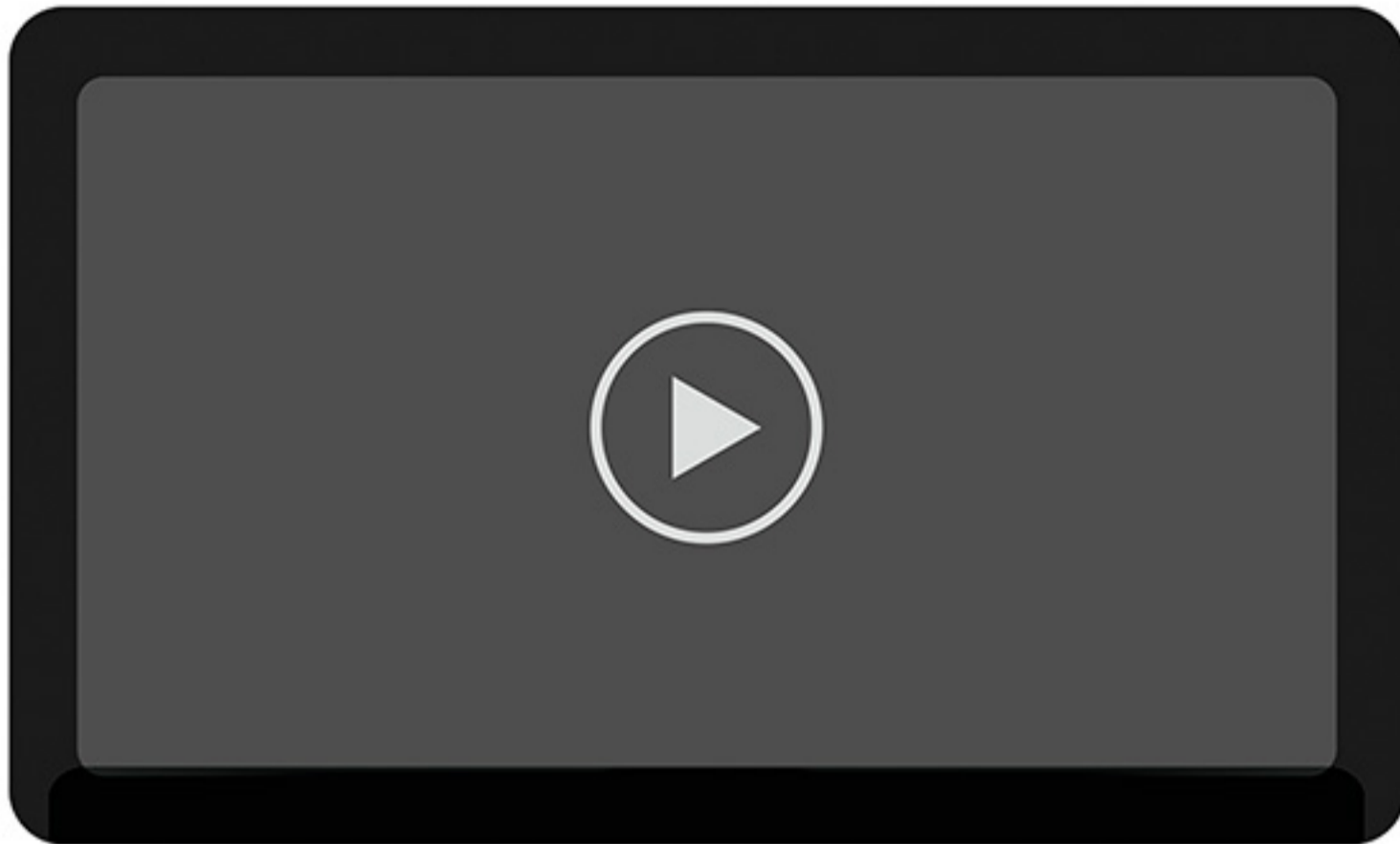

### เอพีซี อินเตอร์เทรด บก.

บริษัท เอพีซี อินเตอร์เทรด จำกัด ก่อตั้งเมื่อวันที่ 26 มิถุนายน 2545 ด้วยประสบการณ์กว่า 20 ปี ในวงการวาล์ว และวิสัยทัศน์ของผู้บริหารระดับสูง ในระยะเริ่มแรกบริษัทฯ ดำเนินธุรกิจเป็นที่ปรึกษาและจัดซื้อจัดหาผลิตภัณฑ์วาล์ว ภายใต้อุปกรณ์การค้ำทั้งในและต่างประเทศ

ต่อมาระยะเวลาผ่านไปเพียงปีเศษๆ ด้วยฐานลูกค้าของบริษัทฯ ที่เพิ่มมากขึ้น บวกกับแนวโน้มตลาดที่ดีขึ้นเรื่อยๆ บริษัทฯ มีการขยายกลุ่มผลิตภัณฑ์ โดยเริ่มต้นที่ การเป็น ผู้จัดจำหน่ายในประเทศไทยสำหรับผลิตภัณฑ์ข้อต่อยาง (Rubber Flexible Joint) ภายใต้อุปกรณ์การค้ำ “ท็อบฟเล็กซ์” เทคโนโลยีการผลิตจากประเทศออสเตรเลีย ด้วยประสบการณ์ผู้บริหารบริษัทฯ ร่วมกับผู้บริหารโรงงานท็อบฟเล็กซ์แห่งประเทศไทย ร่วมกันวิจัยและพัฒนาผลิตภัณฑ์ให้รองรับระบบงานลูกค้าได้มากขึ้น นอกจากนี้มีการเพิ่มเติมผลิตภัณฑ์ในส่วน ข้อต่อสแตนเลส และข้อต่อยางแบบไม่รับแรงดันสำหรับระบบระบายน้ำเสีย

ย่างก้าวต่อมา บริษัทฯ มีการขยายการจำหน่ายผลิตภัณฑ์วาล์วเหล็กหล่อภายใต้อุปกรณ์การค้ำ “คิส์เลอร์” อันได้แก่ บัตเตอร์ฟลายวาล์ว ทั้งรุ่นเวเฟอร์ และรุ่นลึค, เกจวาล์ว, เช็ควาล์ว รุ่นสวิง, รุ่นดูโอ้เพลท และรุ่นโซเลนอยด์, วายสเตรนเนอร์, พุตวาล์ว และบอลวาล์ว รวมถึง วาล์วทองเหลือง, วาล์วสแตนเลส และวาล์วยูพีวีซี อีก

### Address

### APC INTERTRADE CO., LTD.

1/13 Moo3 King-Keaw Rd., Rachateva, Bangplee, Samutprakarn 10540

Tel. : +662 750 3521-2 Fax. : +662 312 4925

Mobile : +668 1751 4800

E-mail : [apcinter\\_topflex@yahoo.com](mailto:apcinter_topflex@yahoo.com)

Website : [www.brandexdirectory.com/apcintertrade](http://www.brandexdirectory.com/apcintertrade)

Contact : Amporn Nitirojpanya



**โคมไฟประดับอาคารหงส์ มีลักษณะหลายแบบให้เลือกดังนี้**

- โคมไฟประดับอาคารหงส์แบบเสาไฟถนนกิ่งเดี่ยว
- โคมไฟประดับอาคารหงส์แบบเสาไฟถนนกิ่งคู่
- โคมไฟประดับอาคารหงส์แบบติดหัวเสา
- โคมไฟประดับอาคารหงส์แบบติดผนัง

**โคมไฟประดับอาคารกิ้งกือ มีลักษณะหลายแบบ ให้เลือกดังนี้**

- โคมไฟประดับอาคารกิ้งกือแบบเสาไฟถนนกิ่งเดี่ยว
- โคมไฟประดับอาคารกิ้งกือแบบเสาไฟถนนกิ่งคู่
- โคมไฟประดับอาคารกิ้งกือแบบติดหัวเสา
- โคมไฟประดับอาคารกิ้งกือแบบติดผนัง

**โคมไฟภายนอก ตกแต่งสวน (Landscape)**

โคมไฟทางเดิน (Bollard)

โคมไฟกิ่ง (Bracket Light)

โคมไฟส่องป้าย (Flood Light)

โคมไฟปักสนาม (Garden Light)

โคมไฟฝังพื้น (Inground)

โคมไฟห้อย (Pendant Light)

โคมไฟสนาม (Pole Light)

โคมไฟหัวเสา (Post Top Light)

โคมไฟสปอร์ตไลท์ (Spot Light)

โคมไฟบันได (Step Light)

โคมไฟผนัง (Wall Mount Light)

โคมไฟใต้น้ำ (UnderWater Light)

โคมไฟถนน (Street Light)

โคมไฟสั่งทำตามแบบ (made to drawing)

รับสั่งผลิตโคมไฟทุกชนิด ตามแบบเฉพาะ โครงการ โคมไฟแปลกต่างๆ ให้คำปรึกษาโดยช่างที่ชำนาญงาน มีบริการซ่อมแซมโคมไฟสินค้าจากบริษัทอื่นๆ ที่เสียหาย ทางโรงงานเรามีบริการออกแบบ ผลิตอะไหล่โคมไฟ ซ่อมแซมตามความต้องการของลูกค้า

รับหล่ออลูมิเนียมอัลลอย ไฟเบอร์กลาส เรซิน (made to order)

รับผลิตงานหล่ออลูมิเนียม และสร้างแบบแม่พิมพ์โมลด์สินค้า ตามแบบลูกค้า

รับผลิตงานหล่อไฟเบอร์กลาส และ สร้างแบบแม่พิมพ์โมลด์สินค้า ตามแบบที่ต้องการ

**สินค้าและบริการ**

โคมไฟสั่งทำตามแบบ

งานประดับอาคาร

โคมไฟปักสนาม

โคมไฟสนาม

โคมไฟบันได

โคมไฟฝังพื้น

โคมไฟถนน

โคมไฟผนัง

โคมไฟหัวเสา

โคมไฟห้อย

โคมไฟส่องป้าย

โคมไฟใต้น้ำ

โคมไฟสปอร์ตไลท์

โคมไฟทางเดิน

โคมไฟกิ่ง

รับหล่อลูมิเนียมอัลลอย ไฟเบอร์กลาส เรซิน  
ผลงานและโครงการ

### CHORRUAYLIGHTING CO., LTD.

We design the lighting and manufacture as the outside lamps, Sculpture Lamp, Garden Lighting. We molded the aluminum from the expert more than ten years on the molded aluminum work. And produce beautiful work affordable by all, depend from the customer needs, both large and small work, factory price that you are satisfied manufactured from at least 1 piece and above the price of lamps will vary according to the number of orders.

#### Products & Services

Made to drawing  
Sculpture Light  
Garden Light  
Pole Light  
Step Light  
Inground  
Street Light  
Wall Mount Light  
Post Top Light  
Pendent Light  
Flood Light  
Under Water Light  
Spot Light  
Bollard  
Bracket Light  
Made to order  
Projects



[See More Information](#)

#### Address

### CHORRUAYLIGHTING CO., LTD.

59/188 Kokkrabue, Muang, Samutsakhon 74000

Tel. : +66 34 82 3552 Fax. : +66 34 82 3552

Mobile : +668 1929 1621

E-mail : [crlighting@gmail.com](mailto:crlighting@gmail.com)

Website : [www.brandexdirectory.com/chorruaylighting](http://www.brandexdirectory.com/chorruaylighting)

Contact : Khun Kittiphat Phiensee

CRBOL-0105



## DESCRIPTION

- Cast Aluminium alloy ADC12 body.
- High corrosion resistant powder paint in black color. (Other colors are available on request.)
- Concealed opal glass lens diffuser .
- Silicone rubber gasket against dust and moisture, IP55.
- All fasteners made of stainless steel.
- Integral control gear is mounted to a removable ballast tray.

CRBOL-0106



## ORDERING DATA

LAMP	LAMP HOLDER	WATT(MAX.)
INCANDESCENT	E27	100
COMPACT FLUORESCENT	G24D-3	26
MERCURY VAPOUR	E27	80
METAL HALIDE	E27	70
HIGH PRESSURE SODIUM	E27	70

## DIMENSION

Products ID	W	H	Price
CRBOL-0105	412 mm	500 OR 1000 mm	9,000
CRBOL-0106	412 mm	500 OR 1000 mm	9,000
CRBOL-0107	200 mm	500 OR 1000 mm	5,500
CRBOL-0108	200 mm	500 OR 1000 mm	5,500

CRBOL-0107



CRBOL-0108



## DRAWING



CRBOL-0109



## DESCRIPTION

- Cast Aluminium alloy ADC12 body.
- High corrosion resistant powder paint in black color. (Other colors are available on request.)
- Concealed opal glass lens diffuser .
- Silicone rubber gasket against dust and moisture, IP55.
- All fasteners made of stainless steel.
- Integral control gear is mounted to a removable ballast tray.

CRBOL-0110



## ORDERING DATA

LAMP	LAMP HOLDER	WATT(MAX.)
INCANDESCENT	E27	100
COMPACT FLUORESCENT	G24D-3	26
MERCURY VAPOUR	E27	80
METAL HALIDE	E27	70
HIGH PRESSURE SODIUM	E27	70

## DIMENSION

Products ID	W	H	Price
CRBOL-0109	160 mm	500 OR 1000 mm	5,500
CRBOL-0110	160 mm	500 OR 1000 mm	5,500
CRBOL-0111	160 mm	500 OR 1000 mm	5,500
CRBOL-0112	160 mm	500 OR 1000 mm	5,500

CRBOL-0111



## DRAWING



CRBOL-0112



CRBOL-0113



## DESCRIPTION

- Cast Aluminium alloy ADC12 body.
- High corrosion resistant powder paint in black color. (Other colors are available on request.)
- Ultraviolet stabilized opal white and clear acrylic or glass lens diffuser .
- Silicone rubber gasket against dust and moisture, IP55.
- All fasteners made of stainless steel.
- Integral control gear is mounted to a removable ballast tray.
- Anodized high purity aluminium reflectors.

CRBOL-0114



## ORDERING DATA

LAMP	LAMP HOLDER	WATT(MAX.)
INCANDESCENT	E27	100
COMPACT FLUORESCENT	G24D-3	26
MERCURY VAPOUR	E27	80
METAL HALIDE	E27	70
HIGH PRESSURE SODIUM	E27	70

## DIMENSION

Products ID	W	H	Price
CRBOL-0113	160 mm	500 OR 1000 mm	5,500
CRBOL-0114	160 mm	500 OR 1000 mm	5,500
CRBOL-0115	160 mm	500 OR 1000 mm	5,500
CRBOL-0116	160 mm	500 OR 1000 mm	5,500

CRBOL-0115



## DRAWING



CRBOL-0116



CRBOL-0117



CRBOL-0118

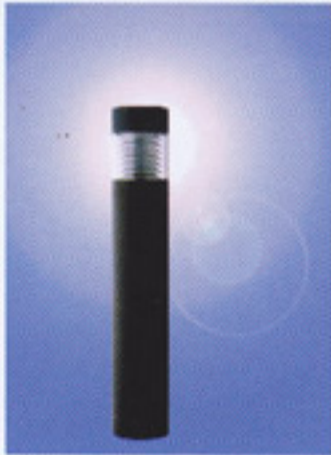

CRBOL-0119



CRBOL-0120



## DESCRIPTION

- Cast Aluminium alloy ADC12 body.
- High corrosion resistant powder paint in black color. (Other colors are available on request.)
- Ultraviolet stabilized opal white and clear acrylic or glass lens diffuser .
- Silicone rubber gasket against dust and moisture, IP55.
- All fasteners made of stainless steel.
- Integral control gear is mounted to a removable ballast tray.
- Anodized high purity aluminium reflectors.

## ORDERING DATA

LAMP	LAMP HOLDER	WATT(MAX.)
INCANDESCENT	E27	100
COMPACT FLUORESCENT	G24D-3	26
MERCURY VAPOUR	E27	80
METAL HALIDE	E27	70
HIGH PRESSURE SODIUM	E27	70

## DIMENSION

Products ID	W	H	Price
CRBOL-0117	160 mm	500 OR 1000 mm	5,800
CRBOL-0118	160 mm	500 OR 1000 mm	5,800
CRBOL-0119	160 mm	500 OR 1000 mm	5,800
CRBOL-0120	160 mm	500 OR 1000 mm	5,800

## DRAWING



CRBOL-0121



## DESCRIPTION

- Cast Aluminium alloy ADC12 body.
- High corrosion resistant powder paint in black color. (Other colors are available on request.)
- Concealed opal glass lens diffuser .
- Silicone rubber gasket against dust and moisture, IP55.
- All fasteners made of stainless steel.
- Integral control gear is mounted to a removable ballast tray.

CRBOL-0122



## ORDERING DATA

LAMP	LAMP HOLDER	WATT(MAX.)
INCANDESCENT	E27	100
COMPACT FLUORESCENT	G24D-3	26
MERCURY VAPOUR	E27	80
METAL HALIDE	E27	70
HIGH PRESSURE SODIUM	E27	70

## DIMENSION

Products ID	W	H	Price
CRBOL-0121	160 mm	500 OR 1000 mm	5,500
CRBOL-0122	160 mm	500 OR 1000 mm	5,500
CRBOL-0123	160 mm	500 OR 1000 mm	5,500
CRBOL-0124	160 mm	500 OR 1000 mm	5,500

CRBOL-0123



## DRAWING



CRBOL-0124



CRBOL-0125



## DESCRIPTION

- Cast Aluminium alloy ADC12 body.
- High corrosion resistant powder paint in black color. (Other colors are available on request.)
- Concealed opal glass lens diffuser .
- Silicone rubber gasket against dust and moisture, IP55.
- All fasteners made of stainless steel.
- Integral control gear is mounted to a removable ballast tray.

CRBOL-0126



## ORDERING DATA

LAMP	LAMP HOLDER	WATT(MAX.)
INCANDESCENT	E27	100
COMPACT FLUORESCENT	G24D-3	26
MERCURY VAPOUR	E27	80
METAL HALIDE	E27	70
HIGH PRESSURE SODIUM	E27	70

## DIMENSION

Products ID	W	H	Price
CRBOL-0125	160 mm	500 OR 1000 mm	5,500
CRBOL-0126	160 mm	500 OR 1000 mm	5,500
CRBOL-0127	160 mm	500 OR 1000 mm	5,500
CRBOL-0128	160 mm	500 OR 1000 mm	5,500

CRBOL-0127



## DRAWING



CRBOL-0128



CRBOL-0129



## DESCRIPTION

- Cast Aluminium alloy ADC12 body.
- High corrosion resistant powder paint in black color. (Other colors are available on request.)
- Concealed opal glass lens diffuser .
- Silicone rubber gasket against dust and moisture, IP55.
- All fasteners made of stainless steel.
- Integral control gear is mounted to a removable ballast tray.

## ORDERING DATA

LAMP	LAMP HOLDER	WATT(MAX.)
INCANDESCENT	E27	100
COMPACT FLUORESCENT	G24D-3	26
MERCURY VAPOUR	E27	80
METAL HALIDE	E27	70
HIGH PRESSURE SODIUM	E27	70

CRBOL-0130



## DIMENSION

Products ID	W	H	Price
CRBOL-0129	197 mm	500 OR 1000 mm	9,000
CRBOL-0130	197 mm	500 OR 1000 mm	8,000
CRBOL-0131	197 mm	500 OR 1000 mm	9,000
CRBOL-0132	197 mm	500 OR 1000 mm	8,000

CRBOL-0131



## DRAWING



CRBOL-0132



CRBOL-0133



## DESCRIPTION

- Cast Aluminium alloy ADC12 body.
- High corrosion resistant powder paint in black color. (Other colors are available on request.)
- Ultraviolet stabilized opal white and clear acrylic or glass lens diffuser .
- Silicone rubber gasket against dust and moisture, IP55.
- All fasteners made of stainless steel.
- Integral control gear is mounted to a removable ballast tray.
- Anodized high purity aluminium reflectors.

CRBOL-0134



## ORDERING DATA

LAMP	LAMP HOLDER	WATT(MAX.)
INCANDESCENT	E27	100
COMPACT FLUORESCENT	G24D-3	26
MERCURY VAPOUR	E27	80
METAL HALIDE	E27	70
HIGH PRESSURE SODIUM	E27	70

## DIMENSION

Products ID	W	H	Price
CRBOL-0133	292 mm	500 OR 1000 mm	8,000
CRBOL-0134	292 mm	500 OR 1000 mm	8,000
CRBOL-0135	292 mm	500 OR 1000 mm	8,000
CRBOL-0136	292 mm	500 OR 1000 mm	8,000

CRBOL-0135



## DRAWING



CRBOL-0136



CRBOL-0137



## DESCRIPTION

- Cast Aluminium alloy ADC12 body.
- High corrosion resistant powder paint in black color. (Other colors are available on request.)
- Concealed opal or clear glass lens diffuser .
- Silicone rubber gasket against dust and moisture, IP55.
- All fasteners made of stainless steel.
- Integral control gear is mounted to a removable ballast tray.

CRBOL-0138



## ORDERING DATA

LAMP	LAMP HOLDER	WATT(MAX.)
INCANDESCENT	E27	100
COMPACT FLUORESCENT	G24D-3	26
MERCURY VAPOUR	E27	80
METAL HALIDE	E27	70
HIGH PRESSURE SODIUM	E27	70

## DIMENSION

Products ID	W	H	Price
CRBOL-0137	140 mm	500 OR 1000 mm	3,500
CRBOL-0138	140 mm	500 OR 1000 mm	3,500
CRBOL-0139	140 mm	500 OR 1000 mm	3,500
CRBOL-0140	140 mm	500 OR 1000 mm	3,500

CRBOL-0139



CRBOL-0140



## DRAWING



CRBOL-0141



## DESCRIPTION

- Cast Aluminium alloy ADC12 body.
- High corrosion resistant powder paint in black color. (Other colors are available on request.)
- Concealed opal glass lens diffuser .
- Silicone rubber gasket against dust and moisture, IP55.
- All fasteners made of stainless steel.
- Integral control gear is mounted to a removable ballast tray.

CRBOL-0142



## ORDERING DATA

LAMP	LAMP HOLDER	WATT(MAX.)
INCANDESCENT	E27	100
COMPACT FLUORESCENT	G24D-3	26
MERCURY VAPOUR	E27	80
METAL HALIDE	E27	70
HIGH PRESSURE SODIUM	E27	70

CRBOL-0143



## DIMENSION

Products ID	W	H	Price
CRBOL-0141	180 mm	500 OR 1000 mm	5,500
CRBOL-0142	180 mm	500 OR 1000 mm	5,500
CRBOL-0143	180 mm	500 OR 1000 mm	5,500
CRBOL-0144	180 mm	500 OR 1000 mm	5,500
CRBOL-0145	353 mm	500 OR 1000 mm	13,000
CRBOL-0146	298 mm	500 OR 1000 mm	7,000

CRBOL-0144



## DRAWING



CRBOL-0145

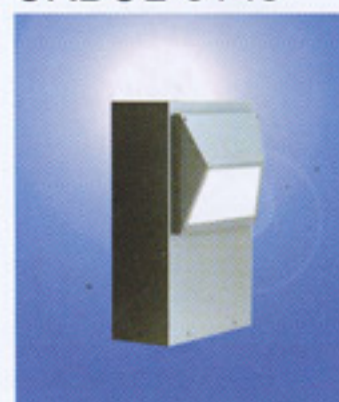

CRBOL-0146



CRBRA-0201



## DESCRIPTION

- Cast Aluminium alloy ADC12 body.
- High corrosion resistant powder paint in black color. (Other colors are available on request.)
- Ultraviolet stabilized opal white and clear glass lens diffuser.
- Silicone rubber gasket against dust and moisture, IP55.
- All fasteners made of stainless steel.
- Integral control gear is mounted to a removable ballast tray.

CRBRA-0202



## ORDERING DATA

LAMP	LAMP HOLDER	WATT(MAX.)
INCANDESCENT	E27	100
COMPACT FLUORESCENT	G24D-3	26
MERCURY VAPOUR	E27	80
METAL HALIDE	E27	70
HIGH PRESSURE SODIUM	E27	70

## DIMENSION

Products ID	W <sub>1</sub>	W <sub>2</sub>	H	Price
CRBRA-0201	282 mm	212 mm	162 mm	2,500
CRBRA-0202	450 mm	330 mm	428 mm	3,800
CRBRA-0203	450 mm	330 mm	428 mm	3,800
CRBRA-0204	450 mm	330 mm	428 mm	4,000

CRBRA-0203



CRBRA-0204



## DRAWING

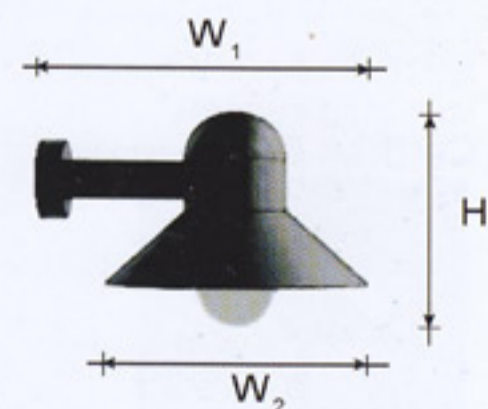

CRBRA-0205



## DESCRIPTION

- Cast Aluminium alloy ADC12 body.
- High corrosion resistant powder paint in black color. (Other colors are available on request.)
- Ultraviolet stabilized opal white and clear acrylic or glass lens diffuser .
- Silicone rubber gasket against dust and moisture, IP55.
- All fasteners made of stainless steel.
- Integral control gear is mounted to a removable ballast tray.

CRBRA-0206



## ORDERING DATA

LAMP	LAMP HOLDER	WATT(MAX.)
INCANDESCENT	E27	100
COMPACT FLUORESCENT	G24D-3	26
MERCURY VAPOUR	E27	80
METAL HALIDE	E27	70
HIGH PRESSURE SODIUM	E27	70

CRBRA-0207



## DIMENSION

Products ID	W <sub>1</sub>	W <sub>2</sub>	H	Price
CRBRA-0205	450 mm	330 mm	377 mm	4,000
CRBRA-0206	450 mm	330 mm	377 mm	4,000
CRBRA-0207	450 mm	330 mm	577 mm	4,500
CRBRA-0208	450 mm	330 mm	577 mm	4,500

CRBRA-0208



## DRAWING

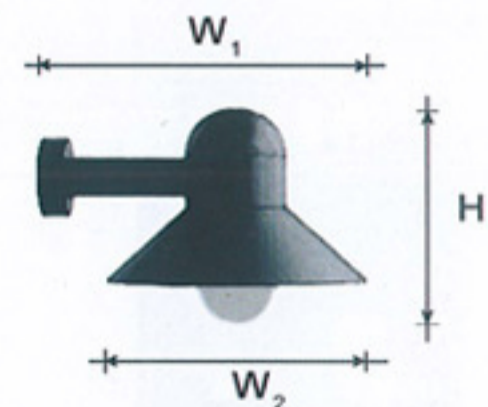

CRBRA-0209



## DESCRIPTION

- Cast Aluminium alloy ADC12 body.
- High corrosion resistant powder paint in black color. (Other colors are available on request.)
- Ultraviolet stabilized opal white and clear acrylic or glass lens diffuser .
- Silicone rubber gasket against dust and moisture, IP55.
- All fasteners made of stainless steel.
- Integral control gear is mounted to a removable ballast tray.
- Anodized high purity aluminium reflectors.

CRBRA-0210



## ORDERING DATA

LAMP	LAMP HOLDER	WATT(MAX.)
INCANDESCENT	E27	100
COMPACT FLUORESCENT	G24D-3	26
MERCURY VAPOUR	E27	80
HIGH PRESSURE SODIUM	E27	70

## DIMENSION

Products ID	W <sub>1</sub>	W <sub>2</sub>	H	Price
CRBRA-0209	547 mm	400 mm	577 mm	7,500
CRBRA-0210	547 mm	400 mm	577 mm	7,000
CRBRA-0211	339 mm	250 mm	388 mm	2,800
CRBRA-0212	405 mm	300 mm	441 mm	3,400

CRBRA-0211



CRBRA-0212



## DRAWING



CRBRA-0213



## DESCRIPTION

- Cast Aluminium alloy ADC12 body.
- High corrosion resistant powder paint in black color. (Other colors are available on request.)
- Ultraviolet stabilized opal white and clear acrylic or glass lens diffuser .
- Silicone rubber gasket against dust and moisture, IP55.
- All fasteners made of stainless steel.
- Integral control gear is mounted to a removable ballast tray.

CRBRA-0214



## ORDERING DATA

LAMP	LAMP HOLDER	WATT(MAX.)
INCANDESCENT	E27	100
COMPACT FLUORESCENT	G24D-3	26
MERCURY VAPOUR	E27	80
METAL HALIDE	E27	70
HIGH PRESSURE SODIUM	E27	70

## DIMENSION

Products ID	W <sub>1</sub>	W <sub>2</sub>	H	Price
CRBRA-0213	450 mm	330 mm	377 mm	5,000
CRBRA-0214	450 mm	330 mm	377 mm	5,000
CRBRA-0215	450 mm	330 mm	577 mm	4,800
CRBRA-0216	400 mm	250 mm	577 mm	3,600

CRBRA-0215



CRBRA-0216



## DRAWING



CRBRA-0217



## DESCRIPTION

- Cast Aluminium alloy ADC12 body.
- High corrosion resistant powder paint in black color. (Other colors are available on request.)
- Ultraviolet stabilized opal white and clear acrylic or glass lens diffuser .
- Silicone rubber gasket against dust and moisture, IP55.
- All fasteners made of stainless steel.
- Integral control gear is mounted to a removable ballast tray.
- Anodized high purity aluminium reflectors.

CRBRA-0218



## ORDERING DATA

LAMP	LAMP HOLDER	WATT(MAX.)
INCANDESCENT	E27	100
COMPACT FLUORESCENT	G24D-3	26
MERCURY VAPOUR	E27	80
METAL HALIDE	E27	70
HIGH PRESSURE SODIUM	E27	70

## DIMENSION

Products ID	W <sub>1</sub>	W <sub>2</sub>	H	Price
CRBRA-0217	250 mm	405 mm	577 mm	7,200
CRBRA-0218	400 mm	547 mm	577 mm	8,200
CRBRA-0219	400 mm	547 mm	388 mm	8,200
CRBRA-0220	400 mm	547 mm	441 mm	7,600

CRBRA-0219



## DRAWING

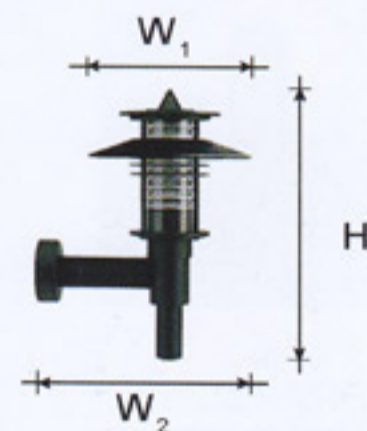

CRBRA-0220



CRBRA-0221



CRBRA-0222



CRBRA-0223



CRBRA-0224



CRBRA-0225



## DESCRIPTION

- Cast Aluminium alloy ADC12 body.
- High corrosion resistant powder paint in black color. (Other colors are available on request.)
- Ultraviolet stabilized opal white and clear acrylic or glass lens diffuser .
- Silicone rubber gasket against dust and moisture, IP55.
- All fasteners made of stainless steel.
- Integral control gear is mounted to a removable ballast tray.
- Anodized high purity aluminium reflectors.

## ORDERING DATA

LAMP	LAMP HOLDER	WATT(MAX.)
INCANDESCENT	E27	100
COMPACT FLUORESCENT	G24D-3	26
MERCURY VAPOUR	E27	80
METAL HALIDE	E27	70
HIGH PRESSURE SODIUM	E27	70

## DIMENSION

Products ID	W <sub>1</sub>	W <sub>2</sub>	H	Price
CRBRA-0221	212 mm	152 mm	350 mm	3,600
CRBRA-0222	212 mm	152 mm	400 mm	7,200
CRBRA-0223	212 mm	152 mm	350 mm	4,200
CRBRA-0224	212 mm	152 mm	350 mm	3,600
CRBRA-0225	212 mm	152 mm	350 mm	3,600

## DRAWING

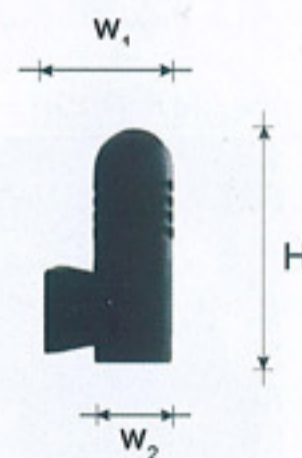

CRBRA-0226



## DESCRIPTION

- Cast Aluminium alloy ADC12 body.
- High corrosion resistant powder paint in black color. (Other colors are available on request.)
- Tempered lens diffuser .
- Silicone rubber gasket against dust and moisture, IP55.
- All fasteners made of stainless steel.
- Integral control gear is mounted to a removable ballast tray.

CRBRA-0227



## ORDERING DATA

LAMP	LAMP HOLDER	WATT(MAX.)
INCANDESCENT	E27	100
COMPACT FLUORESCENT	E27	26
CDM-T	G-12	80
PAR	E27	300

## DIMENSION

Products ID	W <sub>1</sub>	W <sub>2</sub>	H	Price
CRBRA-0226	149 mm	89 mm	160 mm	1,500
CRBRA-0227	149 mm	89 mm	350 mm	2,400
CRBRA-0228	162 mm	102 mm	200 mm	1,700
CRBRA-0229	162 mm	102 mm	450 mm	2,800
CRBRA-0230	200 mm	140 mm	200 mm	2,700
CRBRA-0231	200 mm	140 mm	450 mm	3,500
CRBRA-0232	212 mm	152 mm	200 mm	2,800
CRBRA-0233	212 mm	152 mm	450 mm	3,600
CRBRA-0234	235 mm	175 mm	200 mm	3,500
CRBRA-0235	235 mm	175 mm	450 mm	5,000

CRBRA-0228



CRBRA-0229



## DRAWING

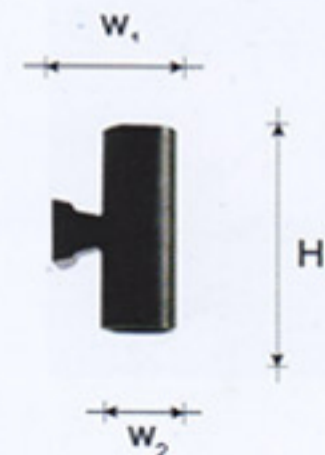

CRBRA-0230



## DESCRIPTION

- Cast Aluminium alloy ADC12 body.
- High corrosion resistant powder paint in black color. (Other colors are available on request.)
- Tempered lens diffuser .
- Silicone rubber gasket against dust and moisture, IP55.
- All fasteners made of stainless steel.
- Integral control gear is mounted to a removable ballast tray.

CRBRA-0231



## ORDERING DATA

LAMP	LAMP HOLDER	WATT(MAX.)
PAR 30	E27	100
PAR 38	E27	100
CDM-T	G12	150
METAL HALIDE	E27	70

## DIMENSION

Products ID	W <sub>1</sub>	W <sub>2</sub>	H	Price
CRBRA-0226	800 mm	1100 mm	700 mm	13,600
CRBRA-0227	800 mm	1125 mm	750 mm	14,000
CRBRA-0228	800 mm	1100 mm	725 mm	13,400
CRBRA-0229	800 mm	1125 mm	700 mm	13,400

CRBRA-0232



## DRAWING



CRBRA-0233



CRFLO-0301



## DESCRIPTION

- Cast Aluminium alloy ADC12 body.
- High corrosion resistant powder paint in black color. (Other colors are available on request.)
- Concealed Tempered lens diffuser .
- Silicone rubber gasket against dust and moisture, IP55.
- All fasteners made of stainless steel.

CRFLO-0302



## ORDERING DATA

LAMP	LAMP HOLDER	WATT(MAX.)
INCANDESCENT	E27	100
COMPACT FLUORESCENT	G24D-3	26
PAR 38	E27	120
PAR 30	E27	120
PAR 20	E27	50
MR 16	GU10	50

CRFLO-0303



## DIMENSION

Products ID	W	H	Price
CRFLO-0301	240 mm	1000 mm	7,000
CRFLO-0302	210 mm	1000 mm	7,000
CRFLO-0303	230 mm	1000 mm	2,000
CRFLO-0304	240 mm	1000 mm	4,500

CRFLO-0304



## DRAWING

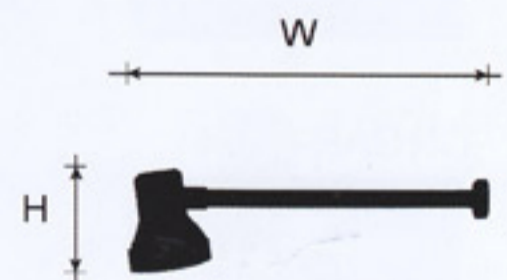

CRGAR-0401



## DESCRIPTION

- Cast Aluminium alloy ADC12 body.
- High corrosion resistant powder paint in black color. (Other colors are available on request.)
- Concealed opal glass lens diffuser .
- Silicone rubber gasket against dust and moisture, IP55.
- All fasteners made of stainless steel.
- Integral control gear is mounted to a removable ballast tray.

CRGAR-0402



## ORDERING DATA

LAMP	LAMP HOLDER	WATT(MAX.)
INCANDESCENT	E27	100
COMPACT FLUORESCENT	G24D-3	26
MERCURY VAPOUR	E27	80
METAL HALIDE	E27	70

## DIMENSION

Products ID	W	H	Price
CRGAR-0401	160 mm	615 mm	3,500
CRGAR-0402	180 mm	615 mm	3,800
CRGAR-0403	160 mm	615 mm	3,500
CRGAR-0404	180 mm	615 mm	3,800

CRGAR-0403



## DRAWING



CRGAR-0404



CRGAR-0405



CRGAR-0406



CRGAR-0407



CRGAR-0408



CRGAR-0409



## DESCRIPTION

- Cast Aluminium alloy ADC12 body.
- High corrosion resistant powder paint in black color.  
(Other colors are available on request.)
- Concealed opal glass lens diffuser .
- Silicone rubber gasket against dust and moisture, IP55.
- All fasteners made of stainless steel.
- Integral control gear is mounted to a removable ballast tray.

## ORDERING DATA

LAMP	LAMP HOLDER	WATT(MAX.)
INCANDESCENT	E27	100
COMPACT FLUORESCENT	G24D-3	26
MERCURY VAPOUR	E27	80
METAL HALIDE	E27	70

## DIMENSION

Products ID	W	H	Price
CRGAR-0405	230 mm	900 mm	5,500
CRGAR-0406	230 mm	900 mm	5,500
CRGAR-0407	230 mm	900 mm	7,500
CRGAR-0408	180 mm	615 mm	3,800
CRGAR-0409	180 mm	615 mm	3,800

## DRAWING



CRING -0501

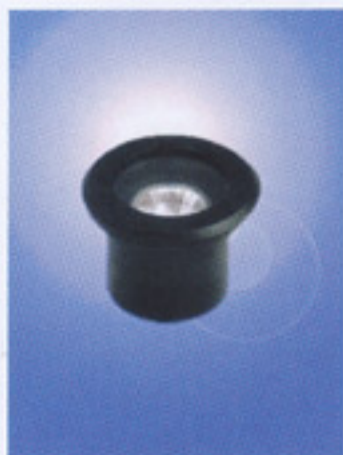

## DESCRIPTION

- Cast Aluminium alloy ADC12 body.
- High corrosion resistant powder paint in black color. (Other colors are available on request.)
- Concealed Tempered lens diffuser .
- Silicone rubber gasket against dust and moisture, IP55.
- All fasteners made of stainless steel.
- Integral control gear is mounted to a removable ballast tray.
- Stainless steel front cover.
- High quality aluminium reflectors.

CRING -0502

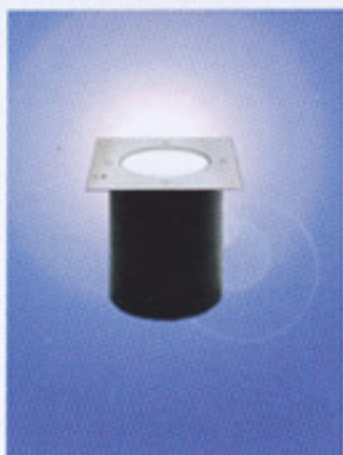

## ORDERING DATA

LAMP	LAMP HOLDER	WATT(MAX.)
INCANDESCENT	E27	100
COMPACT FLUORESCENT	G24D-3	26
PAR 20	E27	50
PAR 30	E27	100
PAR 38	E27	120
CDM-T	G12	150
MR 16	GU10	50

CRING -0503



## DIMENSION

Products ID	W	H	Price
CRING-0501	108 mm	94 mm	2,000
CRING-0502	210 mm	217 mm	5,600
CRING-0503	230 mm	195 mm	5,400

## DRAWING

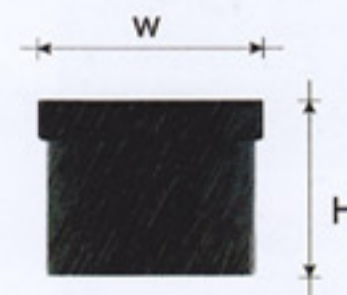

CRING -0504



## DESCRIPTION

- Cast Aluminium alloy ADC12 body.
- High corrosion resistant powder paint in black color. (Other colors are available on request.)
- Concealed Tempered lens diffuser .
- Silicone rubber gasket against dust and moisture, IP55.
- All fasteners made of stainless steel.
- Integral control gear is mounted to a removable ballast tray.
- High quality aluminium reflectors.

CRING -0505



## ORDERING DATA

LAMP	LAMP HOLDER	WATT(MAX.)
INCANDESCENT	E27	100
COMPACT FLUORESCENT	G24D-3	26
PAR 20	E27	50
PAR 30	E27	100
PAR 38	E27	120
CDM-T	G12	150
MR 16	GU10	50

CRING -0506



## DIMENSION

Products ID	W	H	Price
CRING-0504	240 mm	255 mm	5,000
CRING-0505	240 mm	185 mm	4,400
CRING-0506	230 mm	240 mm	4,800
CRING-0507	240 mm	185 mm	4,700

CRING -0507



## DRAWING

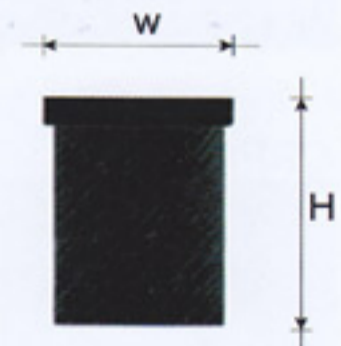

CRPAN -0601



## DESCRIPTION

- Cast Aluminium alloy ADC12 body.
- High corrosion resistant powder paint in black color. (Other colors are available on request.)
- Concealed opal glass lens diffuser .
- Silicone rubber gasket against dust and moisture, IP55.
- All fasteners made of stainless steel.
- Integral control gear is mounted to a removable ballast tray.

CRPAN -0602



## ORDERING DATA

LAMP	LAMP HOLDER	WATT(MAX.)
INCANDESCENT	E27	100
COMPACT FLUORESCENT	G24D-3	26
MERCURY VAPOUR	E27	80
METAL HALIDE	E27	70
HIGH PRESSURE SODIUM	E27	70

CRPAN -0603



## DIMENSION

Products ID	W	H	Price
CRPAN-0601	412 mm	500 OR 1000 mm	7,400
CRPAN-0602	412 mm	500 OR 1000 mm	7,600
CRPAN-0603	412 mm	500 OR 1000 mm	7,600
CRPAN-0604	412 mm	500 OR 1000 mm	7,400

## DRAWING

CRPAN -0604



CRPAN -0605



## DESCRIPTION

- Cast Aluminium alloy ADC12 body.
- High corrosion resistant powder paint in black color.  
(Other colors are available on request.)
- Ultraviolet stabilized opal white and clear acrylic or glass lens diffuser .
- Silicone rubber gasket against dust and moisture, IP55.
- All fasteners made of stainless steel.
- Integral control gear is mounted to a removable ballast tray.
- Anodized high purity aluminium reflectors.

## ORDERING DATA

LAMP	LAMP HOLDER	WATT(MAX.)
INCANDESCENT	E27	100
COMPACT FLUORESCENT	G24D-3	26
MERCURY VAPOUR	E27	80
METAL HALIDE	E27	70
HIGH PRESSURE SODIUM	E27	70

CRPAN -0606



## DIMENSION

Products ID	W	H	Price
CRPAN-0605	400 mm	500 OR 1000 mm	7,000
CRPAN-0606	400 mm	500 OR 1000 mm	7,500
CRPAN-0607	140 mm	250 mm	3,000

CRPAN -0607

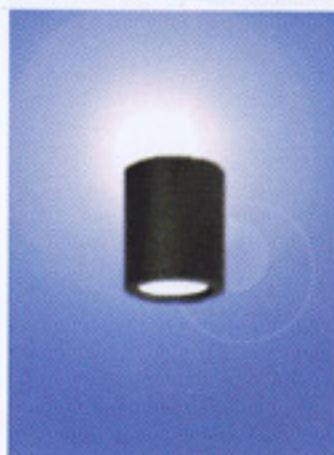

## DRAWING

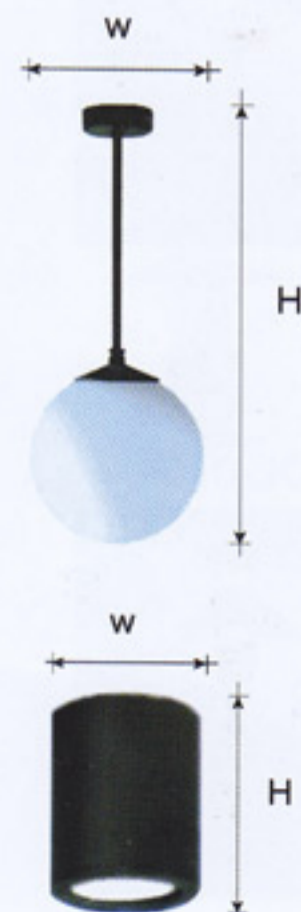

CRPOL-0701



## DESCRIPTION

- Cast Aluminium alloy ADC12 body.
- High corrosion resistant powder paint in black color. (Other colors are available on request.)
- Ultraviolet stabilized opal white and clear acrylic or glass lens diffuser .
- Silicone rubber gasket against dust and moisture, IP55.
- All fasteners made of stainless steel.
- Integral control gear is mounted to a removable ballast tray.
- Anodized high purity aluminium reflectors.

## ORDERING DATA

LAMP	LAMP HOLDER	WATT(MAX.)
INCANDESCENT	E27	100
COMPACT FLUORESCENT	G24D-3	26
MERCURY VAPOUR	E27	80
METAL HALIDE	E27	70
HIGH PRESSURE SODIUM	E27	70

CRPOL-0702



## DIMENSION

Products ID	W	H	Price
CRPOL-0701	600 mm	3000 mm	15,000
CRPOL-0702	500 mm	3000 mm	15,000
CRPOL-0703	800 mm	3000 mm	15,000
CRPOL-0704	500 mm	3000 mm	15,000

CRPOL-0703



## DRAWING



CRPOL-0704



CRPOL-0705



## DESCRIPTION

- Cast Aluminium alloy ADC12 body.
- High corrosion resistant powder paint in black color. (Other colors are available on request.)
- Ultraviolet stabilized opal white and clear acrylic or glass lens diffuser .
- Silicone rubber gasket against dust and moisture, IP55.
- All fasteners made of stainless steel.
- Integral control gear is mounted to a removable ballast tray.
- Anodized high purity aluminium reflectors.

## ORDERING DATA

LAMP	LAMP HOLDER	WATT(MAX.)
INCANDESCENT	E27	100
COMPACT FLUORESCENT	G24D-3	26
MERCURY VAPOUR	E27	80
METAL HALIDE	E27	70
HIGH PRESSURE SODIUM	E27	70

CRPOL-0706



## DIMENSION

Products ID	W	H	Price
CRPOL-0705	800 mm	3000 mm	30,000
CRPOL-0706	1180 mm	3000 mm	18,000
CRPOL-0707	1200 mm	3000 mm	20,000
CRPOL-0708	1200 mm	3000 mm	21,000

CRPOL-0707



## DRAWING



CRPOL-0708



CRPOL-0709



## DESCRIPTION

- Cast Aluminium alloy ADC12 body.
- High corrosion resistant powder paint in black color. (Other colors are available on request.)
- Ultraviolet stabilized opal white and clear acrylic or glass lens diffuser .
- Silicone rubber gasket against dust and moisture, IP55.
- All fasteners made of stainless steel.
- Integral control gear is mounted to a removable ballast tray.
- Anodized high purity aluminium reflectors.

## ORDERING DATA

LAMP	LAMP HOLDER	WATT(MAX.)
INCANDESCENT	E27	100
COMPACT FLUORESCENT	G24D-3	26
MERCURY VAPOUR	E27	80
METAL HALIDE	E27	70
HIGH PRESSURE SODIUM	E27	70

CRPOL-0710



## DIMENSION

Products ID	W	H	Price
CRPOL-0709	500 mm	3000 mm	15,600
CRPOL-0710	600 mm	3000 mm	18,000
CRPOL-0711	350 mm	3000 mm	7,600
CRPOL-0712	152 mm	3000 mm	24,000

CRPOL-0711



## DRAWING



CRPOL-0712



CRPOL-0713



## DESCRIPTION

- Cast Aluminium alloy ADC12 body.
- High corrosion resistant powder paint in black color. (Other colors are available on request.)
- Ultraviolet stabilized opal white and clear acrylic or glass lens diffuser .
- Silicone rubber gasket against dust and moisture, IP55.
- All fasteners made of stainless steel.
- Integral control gear is mounted to a removable ballast tray.
- Anodized high purity aluminium reflectors.

## ORDERING DATA

LAMP	LAMP HOLDER	WATT(MAX.)
INCANDESCENT	E27	100
COMPACT FLUORESCENT	G24D-3	26
MERCURY VAPOUR	E27	80
METAL HALIDE	E27	70
HIGH PRESSURE SODIUM	E27	70

CRPOL-0714



## DIMENSION

Products ID	W	H	Price
CRPOL-0713	394 mm	3000 mm	36,000
CRPOL-0714	850 mm	3000 mm	9,000
CRPOL-0715	1480 mm	3000 mm	36,000
CRPOL-0716	1480 mm	3000 mm	36,000

CRPOL-0715



## DRAWING



CRPOL-0716



CRPOL-0717



CRPOL-0718



CRPOL-0719



CRPOL-0720



CRPOL-0721



CRPOL-0722



CRPOL-0723



## DESCRIPTION

- Cast Aluminium alloy ADC12 body.
- High corrosion resistant powder paint in black color. (Other colors are available on request.)
- Ultraviolet stabilized opal white and clear acrylic or glass lens diffuser .
- Silicone rubber gasket against dust and moisture, IP55.
- All fasteners made of stainless steel.
- Integral control gear is mounted to a removable ballast tray.
- Anodized high purity aluminium reflectors.

## ORDERING DATA

LAMP	LAMP HOLDER	WATT(MAX.)
INCANDESCENT	E27	100
COMPACT FLUORESCENT	G24D-3	26
MERCURY VAPOUR	E27	80
METAL HALIDE	E27	70
HIGH PRESSURE SODIUM	E27	70

## DIMENSION

Products ID	W	H	Price
CRPOL-0717	152 mm	3000 mm	19,000
CRPOL-0718	600 mm	3000 mm	15,600
CRPOL-0719	600 mm	3000 mm	13,000
CRPOL-0720	600 mm	3000 mm	13,600
CRPOL-0721	800 mm	3000 mm	15,000
CRPOL-0722	800 mm	3000 mm	30,000
CRPOL-0723	800 mm	3000 mm	20,000

## DRAWING

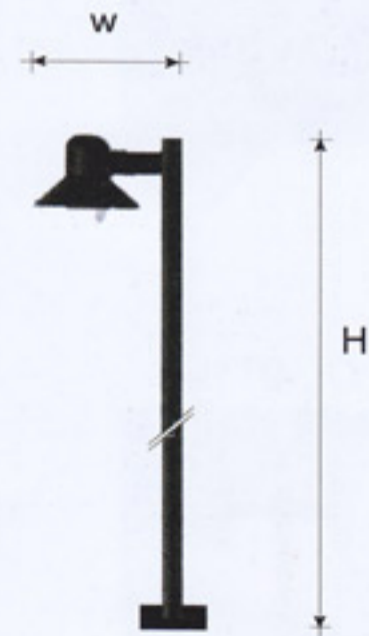

CRPOS-0801



## DESCRIPTION

- Cast Aluminium alloy ADC12 body.
- High corrosion resistant powder paint in black color. (Other colors are available on request.)
- Ultraviolet stabilized opal white and clear acrylic or glass lens diffuser .
- Silicone rubber gasket against dust and moisture, IP55.
- All fasteners made of stainless steel.
- Integral control gear is mounted to a removable ballast tray.
- Anodized high purity aluminium reflectors.

## ORDERING DATA

LAMP	LAMP HOLDER	WATT(MAX.)
INCANDESCENT	E27	100
COMPACT FLUORESCENT	G24D-3	26
MERCURY VAPOUR	E27	80
METAL HALIDE	E27	70
HIGH PRESSURE SODIUM	E27	70

CRPOS-0802



## DIMENSION

Products ID	W	H	Price
CRPOS-0801	412 mm	400 mm	6,400
CRPOS-0802	249 mm	400 mm	5,400
CRPOS-0803	412 mm	400 mm	6,400
CRPOS-0804	412 mm	400 mm	6,400

CRPOS-0803



## DRAWING



CRPOS-0804



CRPOS-0805



## DESCRIPTION

- Cast Aluminium alloy ADC12 body.
- High corrosion resistant powder paint in black color. (Other colors are available on request.)
- Concealed opal glass lens diffuser .
- Silicone rubber gasket against dust and moisture, IP55.
- All fasteners made of stainless steel.
- Integral control gear is mounted to a removable ballast tray.

CRPOS-0806



## ORDERING DATA

LAMP	LAMP HOLDER	WATT(MAX.)
INCANDESCENT	E27	100
COMPACT FLUORESCENT	G24D-3	26
MERCURY VAPOUR	E27	80
METAL HALIDE	E27	70
HIGH PRESSURE SODIUM	E27	70

## DIMENSION

Products ID	W	H	Price
CRPOS-0805	412 mm	400 mm	7,400
CRPOS-0806	412 mm	400 mm	7,400
CRPOS-0807	220 mm	400 mm	3,900
CRPOS-0808	220 mm	400 mm	3,900

CRPOS-0807



## DRAWING

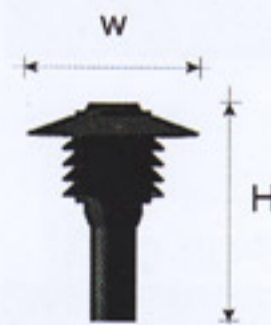

CRPOS-0808



CRPOS-0809



## DESCRIPTION

- Cast Aluminium alloy ADC12 body.
- High corrosion resistant powder paint in black color. (Other colors are available on request.)
- Concealed opal glass lens diffuser .
- Silicone rubber gasket against dust and moisture, IP55.
- All fasteners made of stainless steel.
- Integral control gear is mounted to a removable ballast tray.

CRPOS-0810

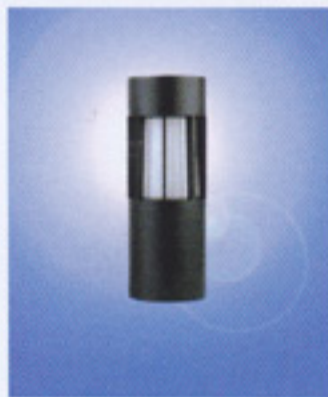

## ORDERING DATA

LAMP	LAMP HOLDER	WATT(MAX.)
INCANDESCENT	E27	100
COMPACT FLUORESCENT	G24D-3	26
MERCURY VAPOUR	E27	80
METAL HALIDE	E27	70
HIGH PRESSURE SODIUM	E27	70

## DIMENSION

Products ID	W	H	Price
CRPOS-0809	160 mm	400 mm	3,900
CRPOS-0810	160 mm	400 mm	3,900
CRPOS-0811	160 mm	400 mm	3,900
CRPOS-0812	160 mm	400 mm	3,900

CRPOS-0811



## DRAWING



CRPOS-0812



CRPOS-0813



## DESCRIPTION

- Cast Aluminium alloy ADC12 body.
- High corrosion resistant powder paint in black color. (Other colors are available on request.)
- Ultraviolet stabilized opal white and clear acrylic or glass lens diffuser .
- Silicone rubber gasket against dust and moisture, IP55.
- All fasteners made of stainless steel.
- Integral control gear is mounted to a removable ballast tray.
- Anodized high purity aluminium reflectors.

CRPOS-0814



## ORDERING DATA

LAMP	LAMP HOLDER	WATT(MAX.)
INCANDESCENT	E27	100
COMPACT FLUORESCENT	G24D-3	26
MERCURY VAPOUR	E27	80
METAL HALIDE	E27	70
HIGH PRESSURE SODIUM	E27	70

## DIMENSION

Products ID	W	H	Price
CRPOS-0813	160 mm	400 mm	3,900
CRPOS-0814	160 mm	400 mm	3,900
CRPOS-0815	160 mm	400 mm	3,900
CRPOS-0816	160 mm	400 mm	3,900

CRPOS-0815



## DRAWING



CRPOS-0816



CRPOS-0821



## DESCRIPTION

- Cast Aluminium alloy ADC12 body.
- High corrosion resistant powder paint in black color. (Other colors are available on request.)
- Concealed opal glass lens diffuser .
- Silicone rubber gasket against dust and moisture, IP55.
- All fasteners made of stainless steel.
- Integral control gear is mounted to a removable ballast tray.

CRPOS-0822



## ORDERING DATA

LAMP	LAMP HOLDER	WATT(MAX.)
INCANDESCENT	E27	100
COMPACT FLUORESCENT	G24D-3	26
MERCURY VAPOUR	E27	80
METAL HALIDE	E27	70
HIGH PRESSURE SODIUM	E27	70

## DIMENSION

Products ID	W	H	Price
CRPOS-0821	160 mm	400 mm	3,900
CRPOS-0822	160 mm	400 mm	3,900
CRPOS-0823	160 mm	400 mm	3,900
CRPOS-0824	160 mm	400 mm	3,900

CRPOS-0823



CRPOS-0824



## DRAWING



CRPOS-0817



## DESCRIPTION

- Cast Aluminium alloy ADC12 body.
- High corrosion resistant powder paint in black color. (Other colors are available on request.)
- Ultraviolet stabilized opal white and clear acrylic or glass lens diffuser .
- Silicone rubber gasket against dust and moisture, IP55.
- All fasteners made of stainless steel.
- Integral control gear is mounted to a removable ballast tray.
- Anodized high purity aluminium reflectors.

CRPOS-0818



## ORDERING DATA

LAMP	LAMP HOLDER	WATT(MAX.)
INCANDESCENT	E27	100
COMPACT FLUORESCENT	G24D-3	26
MERCURY VAPOUR	E27	80
METAL HALIDE	E27	70
HIGH PRESSURE SODIUM	E27	70

## DIMENSION

Products ID	W	H	Price
CRPOS-0817	160 mm	400 mm	4,200
CRPOS-0818	160 mm	400 mm	4,200
CRPOS-0819	160 mm	400 mm	4,200
CRPOS-0820	160 mm	400 mm	4,200

CRPOS-0819



## DRAWING



CRPOS-0820



CRPOS-0825



## DESCRIPTION

- Cast Aluminium alloy ADC12 body.
- High corrosion resistant powder paint in black color. (Other colors are available on request.)
- Concealed opal glass lens diffuser .
- Silicone rubber gasket against dust and moisture, IP55.
- All fasteners made of stainless steel.
- Integral control gear is mounted to a removable ballast tray.

CRPOS-0826



## ORDERING DATA

LAMP	LAMP HOLDER	WATT(MAX.)
INCANDESCENT	E27	100
COMPACT FLUORESCENT	G24D-3	26
MERCURY VAPOUR	E27	80
METAL HALIDE	E27	70
HIGH PRESSURE SODIUM	E27	70

## DIMENSION

Products ID	W	H	Price
CRPOS-0825	160 mm	400 mm	3,900
CRPOS-0826	160 mm	400 mm	3,900
CRPOS-0827	160 mm	400 mm	3,900
CRPOS-0828	160 mm	400 mm	3,900

CRPOS-0827



## DRAWING



CRPOS-0828



CRPOS-0829



## DESCRIPTION

- Cast Aluminium alloy ADC12 body.
- High corrosion resistant powder paint in black color. (Other colors are available on request.)
- Concealed opal glass lens diffuser .
- Silicone rubber gasket against dust and moisture, IP55.
- All fasteners made of stainless steel.
- Integral control gear is mounted to a removable ballast tray.

CRPOS-0830



## ORDERING DATA

LAMP	LAMP HOLDER	WATT(MAX.)
INCANDESCENT	E27	100
COMPACT FLUORESCENT	G24D-3	26
MERCURY VAPOUR	E27	80
METAL HALIDE	E27	70
HIGH PRESSURE SODIUM	E27	70

## DIMENSION

Products ID	W	H	Price
CRPOS-0829	197 mm	400 mm	7,400
CRPOS-0830	197 mm	400 mm	6,400
CRPOS-0831	197 mm	400 mm	7,400
CRPOS-0832	197 mm	400 mm	6,400

CRPOS-0831

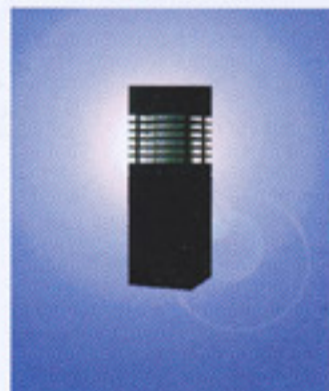

## DRAWING

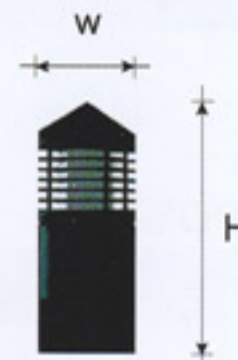

CRPOS-0832



CRPOS-0833



## DESCRIPTION

- Cast Aluminium alloy ADC12 body.
- High corrosion resistant powder paint in black color. (Other colors are available on request.)
- Ultraviolet stabilized opal white and clear acrylic or glass lens diffuser .
- Silicone rubber gasket against dust and moisture, IP55.
- All fasteners made of stainless steel.
- Integral control gear is mounted to a removable ballast tray.
- Anodized high purity aluminium reflectors.

CRPOS-0834



## ORDERING DATA

LAMP	LAMP HOLDER	WATT(MAX.)
INCANDESCENT	E27	100
COMPACT FLUORESCENT	G24D-3	26
MERCURY VAPOUR	E27	80
METAL HALIDE	E27	70
HIGH PRESSURE SODIUM	E27	70

## DIMENSION

Products ID	W	H	Price
CRPOS-0833	292 mm	400 mm	6,400
CRPOS-0834	292 mm	400 mm	6,400
CRPOS-0835	292 mm	400 mm	6,400
CRPOS-0836	292 mm	400 mm	6,400

CRPOS-0835



## DRAWING



CRPOS-0836



CRPOS-0837



## DESCRIPTION

- Cast Aluminium alloy ADC12 body.
- High corrosion resistant powder paint in black color. (Other colors are available on request.)
- Concealed opal or clear glass lens diffuser .
- Silicone rubber gasket against dust and moisture, IP55.
- All fasteners made of stainless steel.
- Integral control gear is mounted to a removable ballast tray.

CRPOS-0838



## ORDERING DATA

LAMP	LAMP HOLDER	WATT(MAX.)
INCANDESCENT	E27	100
COMPACT FLUORESCENT	G24D-3	26
MERCURY VAPOUR	E27	80
METAL HALIDE	E27	70
HIGH PRESSURE SODIUM	E27	70

CRPOS-0839



## DIMENSION

Products ID	W	H	Price
CRPOS-0837	140 mm	350 mm	2,000
CRPOS-0838	140 mm	350 mm	2,000
CRPOS-0839	140 mm	350 mm	2,000
CRPOS-0840	140 mm	350 mm	2,000

CRPOS-0840



## DRAWING



CRPOS-0841



## DESCRIPTION

- Cast Aluminium alloy ADC12 body.
- High corrosion resistant powder paint in black color. (Other colors are available on request.)
- Concealed opal glass lens diffuser .
- Silicone rubber gasket against dust and moisture, IP55.
- All fasteners made of stainless steel.
- Integral control gear is mounted to a removable ballast tray.

CRPOS-0842



## ORDERING DATA

LAMP	LAMP HOLDER	WATT(MAX.)
INCANDESCENT	E27	100
COMPACT FLUORESCENT	G24D-3	26
MERCURY VAPOUR	E27	80
METAL HALIDE	E27	70
HIGH PRESSURE SODIUM	E27	70

## DIMENSION

Products ID	W	H	Price
CRPOS-0841	80 mm	350 mm	3,900
CRPOS-0842	180 mm	350 mm	3,900
CRPOS-0843	180 mm	350 mm	3,900
CRPOS-0844	180 mm	350 mm	3,900

CRPOS-0843



## DRAWING

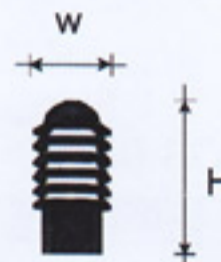

CRPOS-0844



CRPOS-0845



## DESCRIPTION

- Cast Aluminium alloy ADC12 body.
- High corrosion resistant powder paint in black color. (Other colors are available on request.)
- Ultraviolet stabilized opal white and clear acrylic or glass lens diffuser .
- Silicone rubber gasket against dust and moisture, IP55.
- All fasteners made of stainless steel.
- Anodized high purity aluminium reflectors.

CRPOS-0846



## ORDERING DATA

LAMP	LAMP HOLDER	WATT(MAX.)
INCANDESCENT	E27	100
COMPACT FLUORESCENT	E27	26

CRPOS-0847



## DIMENSION

Products ID	W	H	Price
CRPOS-0845	8"	420 mm	2,400
CRPOS-0846	10"	500 mm	2,800
CRPOS-0847	12"	550 mm	3,400
CRPOS-0848	16"	650 mm	7,500

CRPOS-0848



## DRAWING

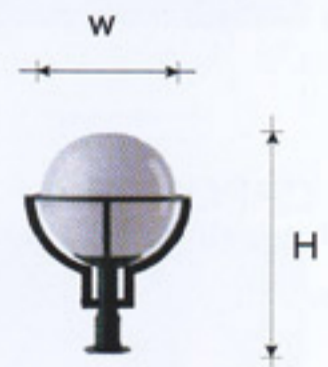

CRSPO -0901



## DESCRIPTION

- Cast Aluminium alloy ADC12 body.
- High corrosion resistant powder paint in black color. (Other colors are available on request.)
- Concealed Tempered lens diffuser .
- Silicone rubber gasket against dust and moisture, IP55.
- All fasteners made of stainless steel.
- Integral control gear is mounted to a removable ballast tray.

CRSPO -0902



## ORDERING DATA

LAMP	LAMP HOLDER	WATT(MAX.)
INCANDESCENT	E27	100
COMPACT FLUORESCENT	G24D-3	26
MERCURY VAPOUR	E27	80
PAR 38	E27	120
PAR 56		

CRSPO -0903



## DIMENSION

Products ID	W <sub>1</sub>	H	Price
CRSPO-0901	230 mm	370 mm	7,000
CRSPO-0902	230 mm	690 mm	7,000
CRSPO-0903	225 mm	328 mm	6,400
CRSPO-0904	225 mm	532 mm	6,400

CRSPO -0904



## DRAWING



CRSPO -0905



## DESCRIPTION

- Cast Aluminium alloy ADC12 body.
- High corrosion resistant powder paint in black color. (Other colors are available on request.)
- Silicone rubber gasket against dust and moisture, IP45.
- All fasteners made of stainless steel.

CRSPO -0906



## ORDERING DATA

LAMP	LAMP HOLDER	WATT(MAX.)
PAR 38	E27	120

CRSPO -0907



## DIMENSION

Products ID	W	H	Price
CRSPO-0905	60 mm	100 mm	900
CRSPO-0906	60 mm	100 mm	900
CRSPO-0907	140 mm	250 mm	1,200
CRSPO-0908	140 mm	470 mm	1,200

CRSPO -0908



## DRAWING



CRSPO -0909



## DESCRIPTION

- Cast Aluminium alloy ADC12 body.
- High corrosion resistant powder paint in black color. (Other colors are available on request.)
- Concealed Tempered lens diffuser .
- Silicone rubber gasket against dust and moisture, IP55.
- All fasteners made of stainless steel.
- Integral control gear is mounted to a removable ballast tray.

CRSPO -0910



## ORDERING DATA

LAMP	LAMP HOLDER	WATT(MAX.)
INCANDESCENT	E27	100
COMPACT FLUORESCENT	G24D-3	26
MERCURY VAPOUR	E27	80
METAL HALIDE	E27	70
PAR 38	E27	120
CDM-T	G12	150
MR 16	GU10	50

CRSPO -0911



## DIMENSION

Products ID	W <sub>1</sub>	H	Price
CRSPO-0909	230 mm	328 mm	7,000
CRSPO-0910	230 mm	618 mm	7,000
CRSPO-0911	70 mm	350 mm	2,400
CRSPO-0912	70 mm	493 mm	3,600

CRSPO -0912



## DRAWING

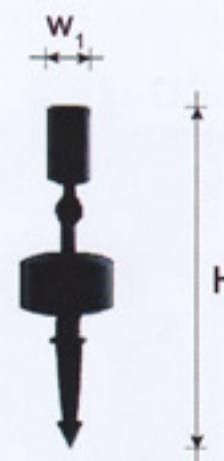

CRSPO-0913



## DESCRIPTION

- Cast Aluminium alloy ADC12 body.
- High corrosion resistant powder paint in black color. (Other colors are available on request.)
- Concealed Tempered lens diffuser .
- Silicone rubber gasket against dust and moisture, IP55.
- All fasteners made of stainless steel.
- Remote Transformer in Waterproof Box.

CRSPO-0914



## ORDERING DATA

LAMP	LAMP HOLDER	WATT(MAX.)
MR 16	GU10	50

CRSPO-0915



## DIMENSION

Products ID	W <sub>1</sub>	W <sub>2</sub>	H	Price
CRSPO-0913	135 mm	105 mm	170 mm	3,000
CRSPO-0914	135 mm	105 mm	380 mm	3,000
CRSPO-0915	105 mm	105 mm	170 mm	2,900
CRSPO-0916	105 mm	105 mm	380 mm	2,900

## DRAWING

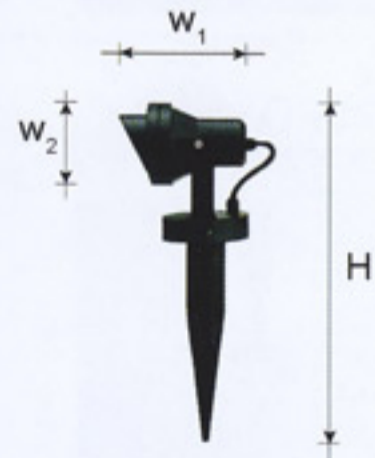

CRSPO-0916



CRSTE-1006

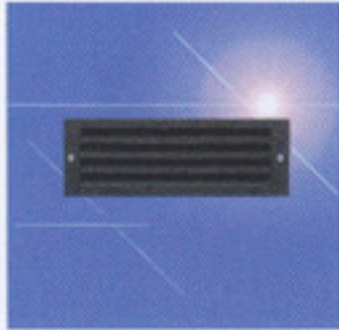

## DESCRIPTION

- Cast Aluminium alloy ADC12 body.
- High corrosion resistant powder paint in black color. (Other colors are available on request.)
- Ultraviolet stabilized opal white and clear acrylic lens diffuser.
- Silicone rubber gasket against dust and moisture, IP55.
- All fasteners made of stainless steel.
- Integral control gear is mounted to a removable ballast tray.

CRSTE-1007



## ORDERING DATA

LAMP	LAMP HOLDER	WATT(MAX.)
INCANDESCENT	E27	100
COMPACT FLUORESCENT	G24D-1	13
COMPACT FLUORESCENT	G24D-2	18
COMPACT FLUORESCENT	G24D-3	26
COMPACT FLUORESCENT	G23	9

CRSTE-1008

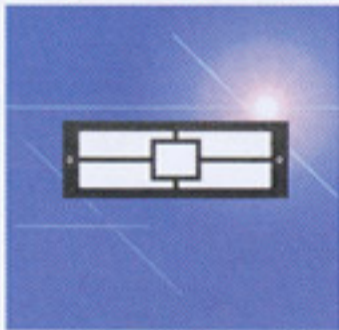

## DIMENSION

Products ID	W	H	Price
CRSTE-1006	230 mm	80 mm	1,600
CRSTE-1007	230 mm	80 mm	1,600
CRSTE-1008	230 mm	80 mm	1,600
CRSTE-1009	230 mm	80 mm	1,600
CRSTE-1010	230 mm	80 mm	1,600

CRSTE-1009



## DRAWING

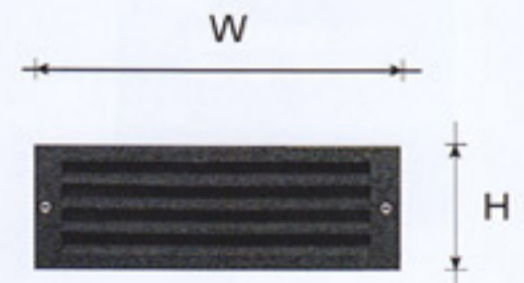

CRSTE-1010

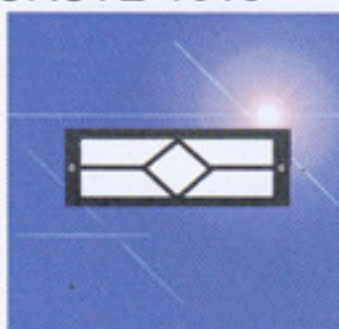

CRSTE-1001

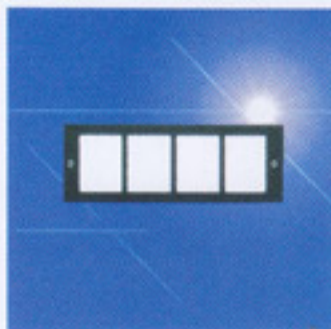

## DESCRIPTION

- Cast Aluminium alloy ADC12 body.
- High corrosion resistant powder paint in black color. (Other colors are available on request.)
- Ultraviolet stabilized opal white and clear acrylic lens diffuser.
- Silicone rubber gasket against dust and moisture, IP55.
- All fasteners made of stainless steel.
- Integral control gear is mounted to a removable ballast tray.

CRSTE-1002



## ORDERING DATA

LAMP	LAMP HOLDER	WATT(MAX.)
INCANDESCENT	E27	100
COMPACT FLUORESCENT	G24D-1	13
COMPACT FLUORESCENT	G24D-2	18
COMPACT FLUORESCENT	G24D-3	26
COMPACT FLUORESCENT	G23	9

CRSTE-1003



## DIMENSION

Products ID	W	H	Price
CRSTE-1001	230 mm	80 mm	1,600
CRSTE-1002	230 mm	80 mm	1,600
CRSTE-1003	230 mm	80 mm	1,600
CRSTE-1004	230 mm	80 mm	1,600
CRSTE-1005	230 mm	80 mm	1,600

CRSTE-1004



## DRAWING

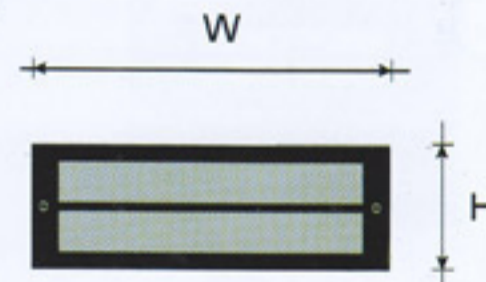

CRSTE-1005

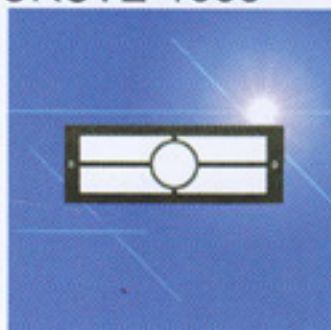

CRSTE-1011



CRSTE-1012



Cover box

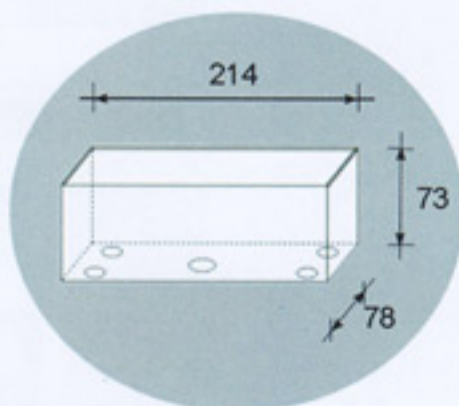
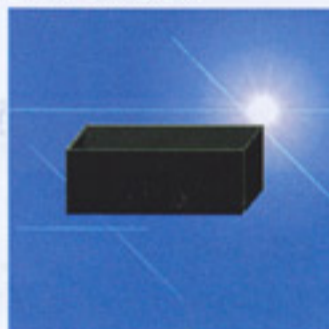

## DESCRIPTION

- Cast Aluminium alloy ADC12 body.
- High corrosion resistant powder paint in black color. (Other colors are available on request.)
- Ultraviolet stabilized opal white and clear acrylic lens diffuser.
- Silicone rubber gasket against dust and moisture, IP55.
- All fasteners made of stainless steel.
- Integral control gear is mounted to a removable ballast tray.

## ORDERING DATA

LAMP	LAMP HOLDER	WATT(MAX.)
INCANDESCENT	E27	100
COMPACT FLUORESCENT	G24D-1	13
COMPACT FLUORESCENT	G24D-2	18
COMPACT FLUORESCENT	G24D-3	26
COMPACT FLUORESCENT	G23	9

## DIMENSION

Products ID	W	H	Price
CRSTE-1011	230 mm	80 mm	1,600
CRSTE-1012	230 mm	80 mm	1,600
Cover box			700

## DRAWING

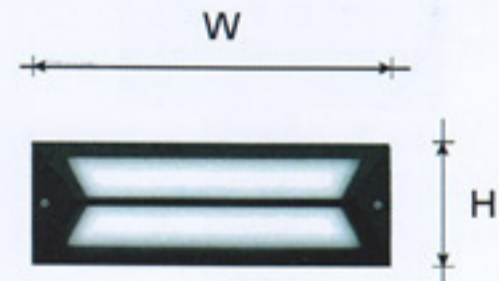

CRWAL -1101



## DESCRIPTION

- Cast Aluminium alloy ADC12 body.
- High corrosion resistant powder paint in black color. (Other colors are available on request.)
- Ultraviolet stabilized opal white and clear acrylic lens diffuser .
- Silicone rubber gasket against dust and moisture, IP55.
- All fasteners made of stainless steel.
- Integral control gear is mounted to a removable ballast tray.

## ORDERING DATA

LAMP	LAMP HOLDER	WATT(MAX.)
INCANDESCENT	E27	100
COMPACT FLUORESCENT	G24D-3	26

CRWAL -1102



## DIMENSION

Products ID	W	H	Price
CRWAL-1101	275 mm	210 mm	2,000
CRWAL-1102	275 mm	68 mm	2,000
CRWAL-1103	275 mm	68 mm	2,000
CRWAL-1104	275 mm	68 mm	1,900

CRWAL -1103

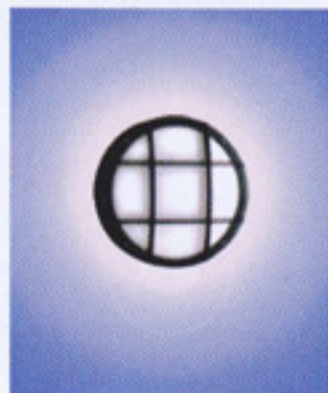

## DRAWING

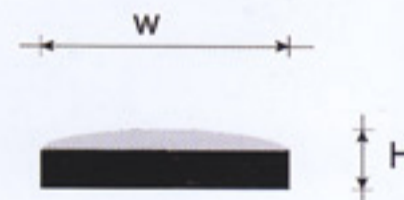

CRWAL -1104

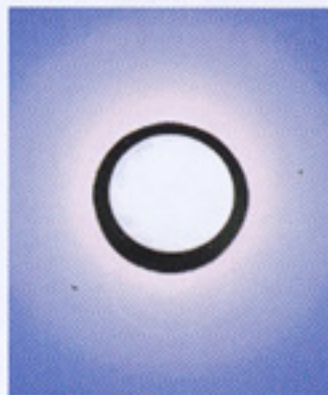

CRWAL -1105



## DESCRIPTION

- Cast Aluminium alloy ADC12 body.
- High corrosion resistant powder paint in black color. (Other colors are available on request.)
- Ultraviolet stabilized opal white and clear acrylic lens diffuser .
- Silicone rubber gasket against dust and moisture, IP55.
- All fasteners made of stainless steel.
- Integral control gear is mounted to a removable ballast tray.

## ORDERING DATA

LAMP	LAMP HOLDER	WATT(MAX.)
INCANDESCENT	E27	100
COMPACT FLUORESCENT	G24D-3	26

CRWAL -1106



## DIMENSION

Products ID	W	H	Price
CRWAL-1105	275 mm	120 mm	2,000
CRWAL-1106	275 mm	68 mm	2,000
CRWAL-1107	275 mm	68 mm	2,000
CRWAL-1108	275 mm	68 mm	2,000

CRWAL -1107



## DRAWING

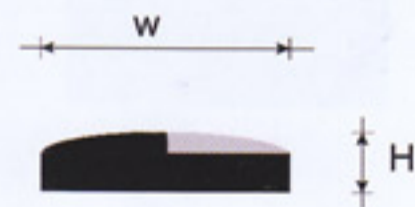

CRWAL -1108



CRWAL -1109



## DESCRIPTION

- Cast Aluminium alloy ADC12 body.
- High corrosion resistant powder paint in black color. (Other colors are available on request.)
- Ultraviolet stabilized opal white and clear acrylic lens diffuser .
- Silicone rubber gasket against dust and moisture, IP55.
- All fasteners made of stainless steel.
- Integral control gear is mounted to a removable ballast tray.

## ORDERING DATA

LAMP	LAMP HOLDER	WATT(MAX.)
INCANDESCENT	E27	100
COMPACT FLUORESCENT	G24D-3	26

CRWAL -1110



## DIMENSION

Products ID	W <sub>1</sub>	W <sub>2</sub>	H	Price
CRWAL-1109	305 mm	305 mm	130 mm	3,600
CRWAL-1110	305 mm	305 mm	130 mm	3,600
CRWAL-1111	305 mm	305 mm	120 mm	3,600
CRWAL-1112	305 mm	305 mm	120 mm	34,00

CRWAL -1111



## DRAWING

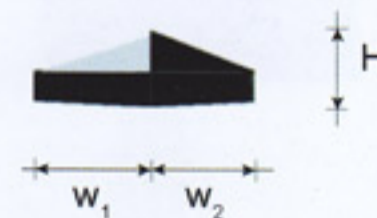

CRWAL -1112

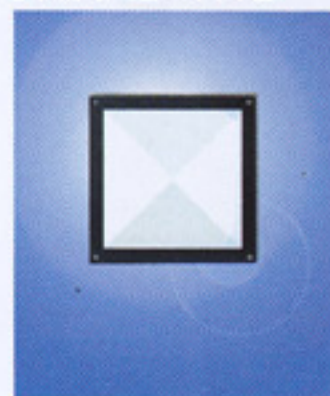

CRWAL -1113

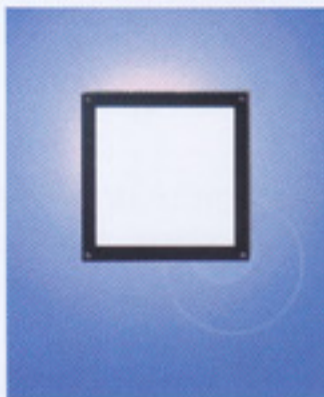

## DESCRIPTION

- Cast Aluminium alloy ADC12 body.
- High corrosion resistant powder paint in black color. (Other colors are available on request.)
- Ultraviolet stabilized opal white and clear acrylic lens diffuser .
- Silicone rubber gasket against dust and moisture, IP55.
- All fasteners made of stainless steel.
- Integral control gear is mounted to a removable ballast tray.

## ORDERING DATA

LAMP	LAMP HOLDER	WATT(MAX.)
INCANDESCENT	E27	100
COMPACT FLUORESCENT	G24D-3	26

CRWAL -1114



## DIMENSION

Products ID	W	H	Price
CRWAL-1113	240 mm	65 mm	2,600
CRWAL-1114	240 mm	65 mm	3,400
CRWAL-1115	240 mm	65 mm	3,000
CRWAL-1116	240 mm	65 mm	3,000

CRWAL -1115



## DRAWING



CRWAL -1116



CRUND-1201



## DESCRIPTION

- Cast Aluminium alloy ADC12 body.
- High corrosion resistant powder paint in black color. (Other colors are available on request.)
- Ultraviolet stabilized opal white glass lens diffuser or tempered glass.
- Silicone rubber gasket against dust and moisture, IP68.
- All fasteners made stainless steel.

CRUND-1202



## ORDERING DATA

LAMP	LAMP HOLDER	WATT(MAX.)
MR16	GU10	50
PAR 38	E27	120

## DIMENSION

Products ID	W	H	Price
CRUND-1201	110 mm	135 mm	8,600
CRUND-1202	110 mm	135 mm	8,600
CRUND-1203	105 mm	170 mm	7,600
CRUND-1204	160 mm	180 mm	2,000

CRUND-1203



## DRAWING



CRUND-1204



CRSTR-1301



CRSTR-1302



CRSTR-1303



CRSTR-1304



CRSTR-1305



## DESCRIPTION

- Cast Aluminium alloy ADC12 body.
- High corrosion resistant powder paint in black color.  
(Other colors are available on request.)
- Ultraviolet stabilized opal white and clear acrylic or glass lens diffuser or tempered glass
- Silicone rubber gasket against dust and moisture, IP55.
- All fasteners made of stainless steel.
- Integral control gear is mounted to a removable ballast tray.
- Anodized high purity aluminium reflectors.

## ORDERING DATA

LAMP	LAMP HOLDER	WATT(MAX.)
MERCURY VAPOUR	E27	250
METAL HALIDE	E40	400
CDM-T	G12	400

## DIMENSION

Products ID	W	H	Price
CRSTR-1301	729 mm	4000 mm	34,000
CRSTR-1302	575 mm	4000 mm	30,000
CRSTR-1303	800 mm	4000 mm	34,000
CRSTR-1304	675 mm	4000 mm	20,000
CRSTR-1305	695 mm	4000 mm	40,000

## DRAWING



CRFound



## DESCRIPTION

- Cast Aluminium alloy ADC12 body.
- High corrosion resistant powder paint in black color. (Other colors are available on request.)
- made to order on request.

CRFound1



## ORDERING DATA

LAMP	LAMP HOLDER	WATT(MAX.)
INCANDESCENT	E27	100
COMPACT FLUORESCENT	G24D-3	26
MERCURY VAPOUR	E40	250
METAL HALIDE	E40	250
HIGH PRESSURE SODIUM	E40	250

CRFound2



## DIMENSION

Products ID	W	H
CRFound		
CRFound1		
CRFound2		
CRSeries5150		
CRSeries5151		
CRSeries5152		
CRSeries5153		

CRSeries5150



## DRAWING



CRSeries5151



CRSeries5152



CRSeries5153



CRSeries5154



## DESCRIPTION

- Cast Aluminium alloy ADC12 body.
- High corrosion resistant powder paint in black color.  
(Other colors are available on request.)
- made to order on request.

CRSeries5155



## ORDERING DATA

LAMP	LAMP HOLDER	WATT(MAX.)
INCANDESCENT	E27	100
COMPACT FLUORESCENT	G24D-3	26
MERCURY VAPOUR	E40	250
METAL HALIDE	E40	250
HIGH PRESSURE SODIUM	E40	250

CRSeries5156



## DIMENSION

Products ID	W	H
-------------	---	---

CRSeries5154-5162

CRSeries5157



## DRAWING



CRSeries5158



CRSeries5159



CRSeries5160



CRSeries5161



CRSeries5162



CRSeries5164



CRSeries5165

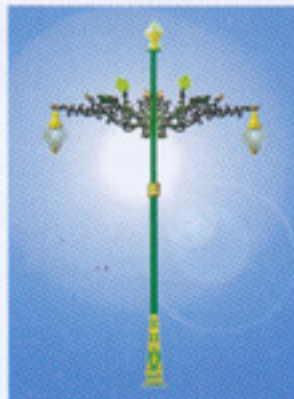

CRSeries5166



CRSeries51514



CRSeries2150

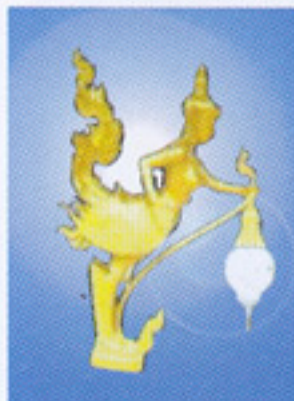

CRSeries2151



CRSeries3150



CRSeries4150



CRSeries4151



## DESCRIPTION

- Cast Aluminium alloy ADC12 body.
- High corrosion resistant powder paint in black color. (Other colors are available on request.)
- made to order on request.

## ORDERING DATA

LAMP	LAMP HOLDER	WATT(MAX.)
INCANDESCENT	E27	100
COMPACT FLUORESCENT	G24D-3	26
MERCURY VAPOUR	E40	250
METAL HALIDE	E40	250
HIGH PRESSURE SODIUM	E40	250

## DIMENSION

Products ID	W	H
CRSeries5164-5166		
CRSeries51514		
CRSeries2150-2151		
CRSeries3150		
CRSeries4150-4151		

## DRAWING

